



Modulation Rate Adaptation in Urban and Vehicular Environments:

Cross-Layer Implementation and Experimental Evaluation

Joseph Camp
Rice Networks Group
Advisor: Prof. Edward Knightly
ACM MobiCom 2008



Background: Link Characteristics

- Time-varying link quality
 - Mobility of sender, receiver, or obstacles
 - Multiple paths existing
- Ideal modulation rate for channel condition
 - Modulation rate with **highest throughput** for channel condition

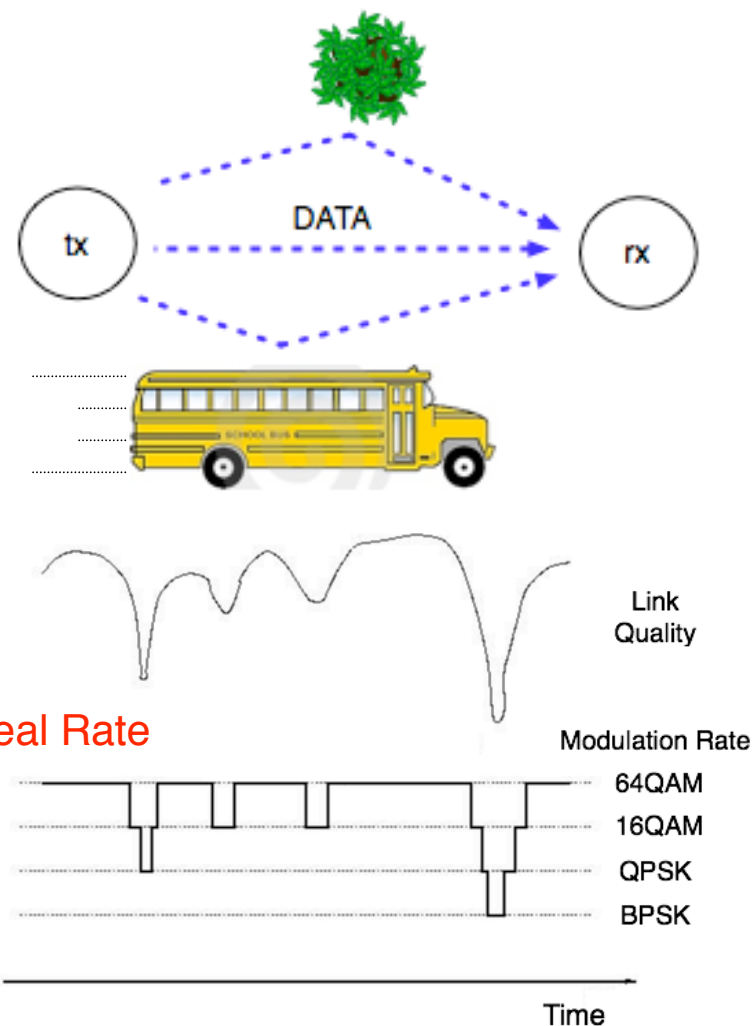



Goal of Protocol Designer

- Use available information (loss, SNR, ...) to track ideal modulation rate
- Many protocols have been invented
 - ARF, RBAR, OAR, RRAA, CARA, ONOE, ...



Ground Truth

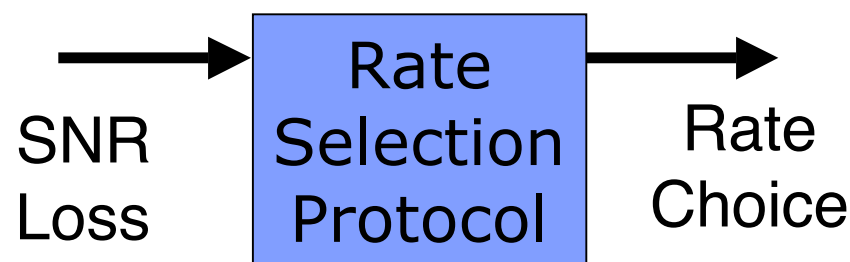

Real System



Problem

- ALL existing rate adaptation algorithms **fail** to track the ideal rate
 - Urban propagation environment
 - Even with non-mobile sender and receiver
 - Result = loss and under-utilization

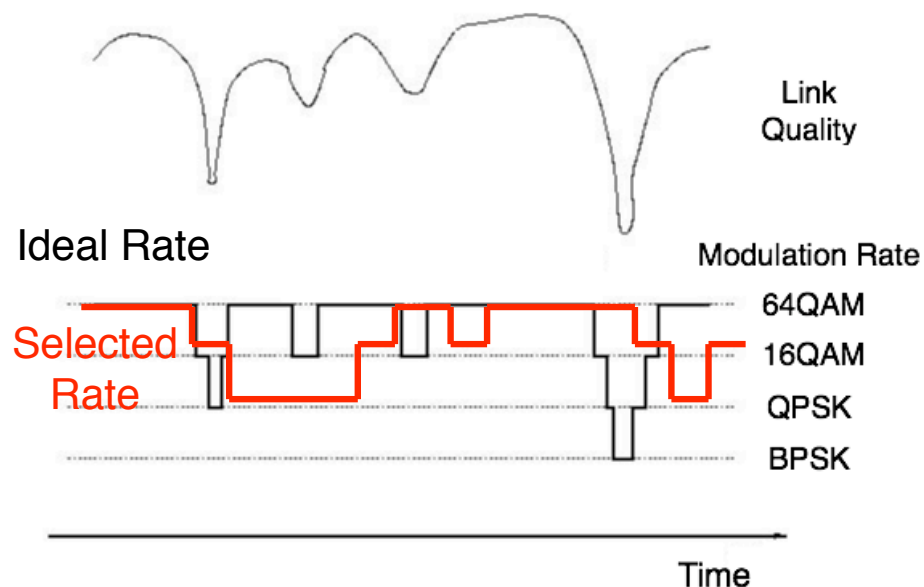



Objective

- Understand the origins of the failure to track link variation
- Identify core mechanisms needed to succeed in urban channels



Methodology

- Unified Implementation Platform
 - Implement multiple algorithms on a common platform
 - First implementation of SNR-based protocols
- Extract General Rate Adaptation Principles
 - Evaluate rate selection accuracy *packet-by-packet*
 - Compare against ideal rate found via exhaustive search
 - Use *repeatable* controlled channels and
 - *Accurately measured outdoor* channels
- Design core mechanisms to track real-world link variation

Wireless Open-Access Research Platform (WARP)



- Limits of Off-the-shelf platforms
 - Programmability and observability
- WARP is clean-slate MAC and PHY, needed to implement:
 - CSMA/CA (802.11-like MAC)
- Cross-layer rate adaptation framework
 - Core mechanisms for rate selection protocols
 - Channel measurements
 - Evaluation of selected rate versus ideal rate

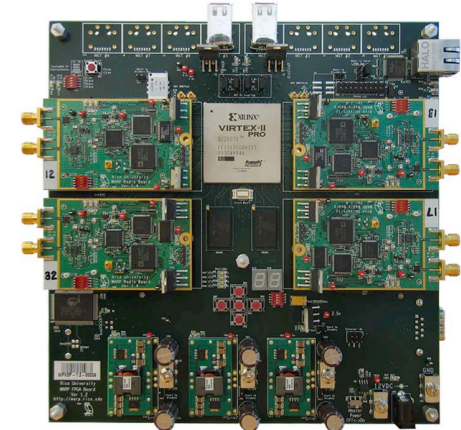

Virtex-II Pro FPGA



Core Mechanisms for Rate Adaptation

- Loss-based
 - Averaging over window
 - Consecutive
 - Collision/Fading Differentiation

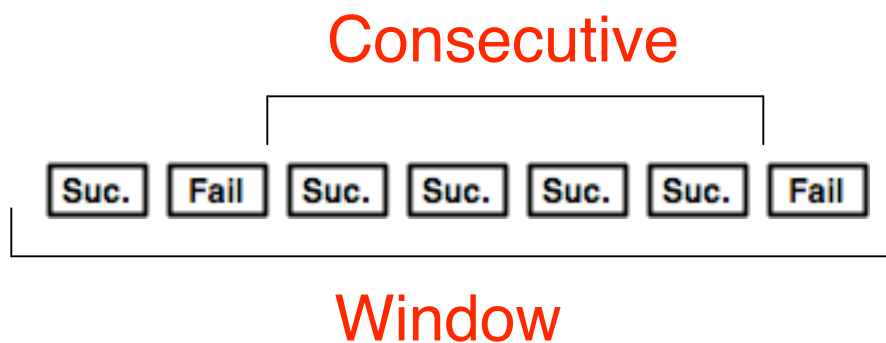

First to implement

- SNR-based
 - Measure SNR per data packet
 - Opportunistic
 - Better channel



Goal to track ideal,
why not measure?



Rate Adaptation Accuracy

- Ideal rate found via exhaustive search of channel condition
- Consider case where at least one modulation rate succeeds
- Rate Selection Accuracy Categories
 - Over-selection (loss)
 - Accurate (achieving optimal rate)
 - Under-selection (under-utilization)

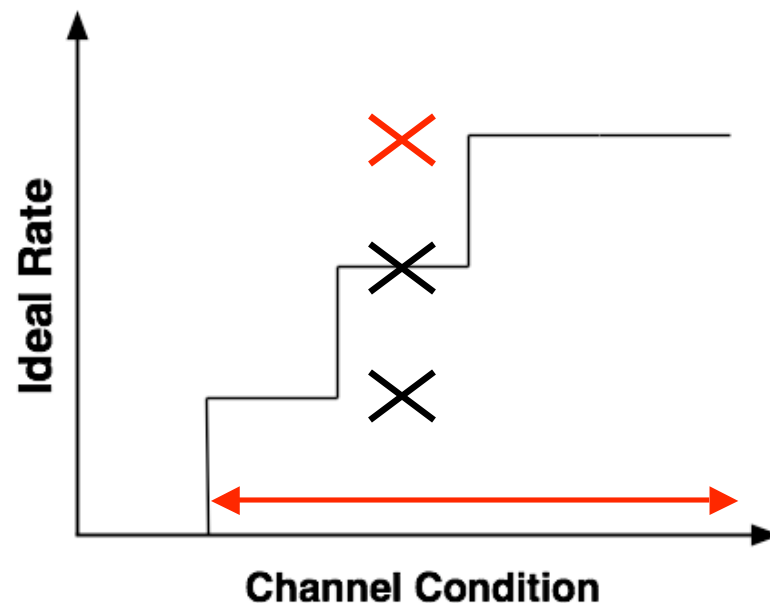

Header	Payload
Rate, SNR	Success/ Failure



Experimental Design

- Repeatable channels
 - Mean channel quality
 - Channel fading/coherence time
 - Multipath effect and interference

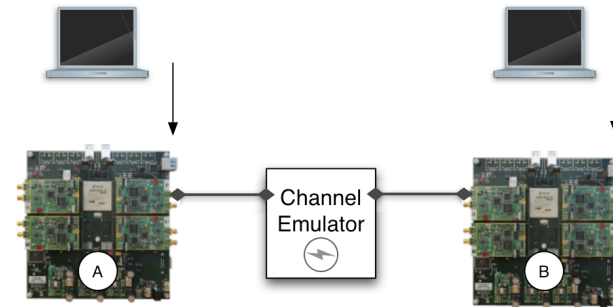

- Accurately measured urban channels
 - Residential and downtown scenarios
 - Measure coherence time
 - Static and Vehicular Topologies

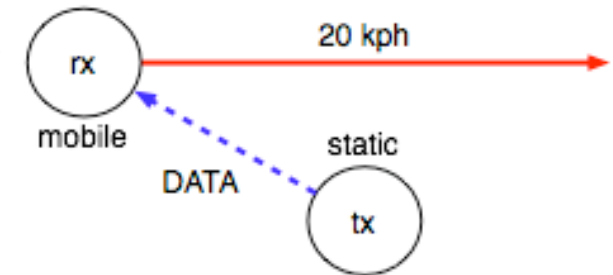

- Competing links (in paper)
 - Indoor, controlled environment
 - Urban environment

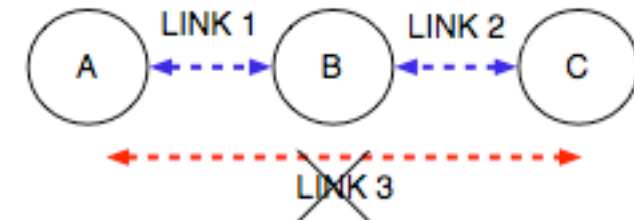



Impact of Coherence Time

- Issue: Increase fading of the channel to evaluate if rate adaptation can track
- Similar performance with long coherence of channel
 - SNR: high overhead penalty (contrasts result of protocol designer)
 - Opportunistic: overcomes RTS/CTS overhead penalty
- Dissimilar performance at short coherence of channel

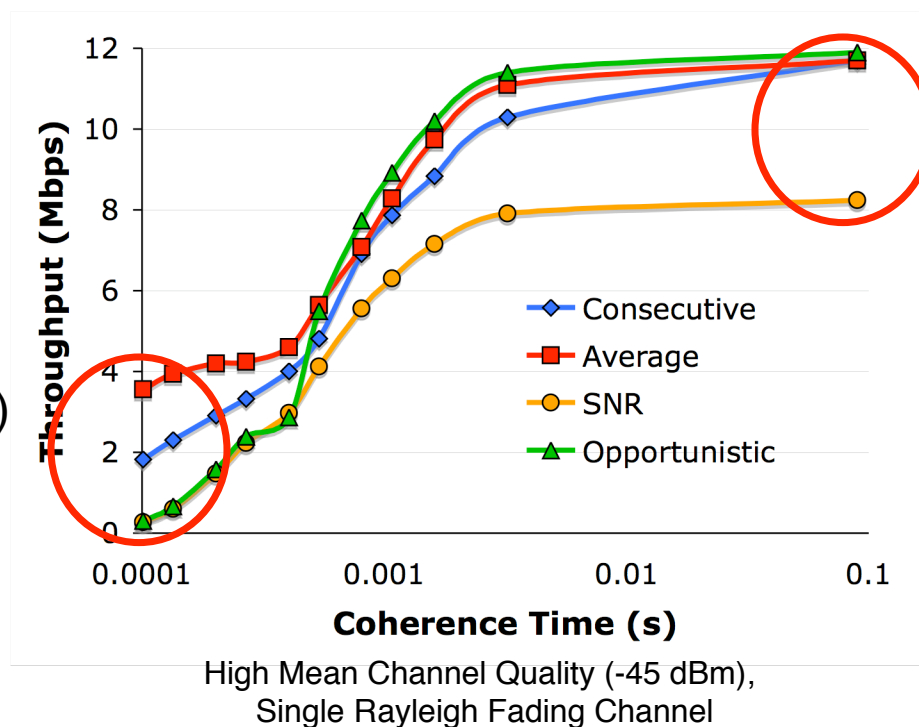



Opposite Rate Choice Inaccuracies

- Issue: Packet-by-packet accuracy to reveal why throughput is low
- Average vs. consecutive mechanisms
 - Consecutive low due to **underselection**
- SNR: extremely low throughput
 - Due to **overselection** (loss)
- **Per-packet analysis needed to show poor rate adaptation behavior**

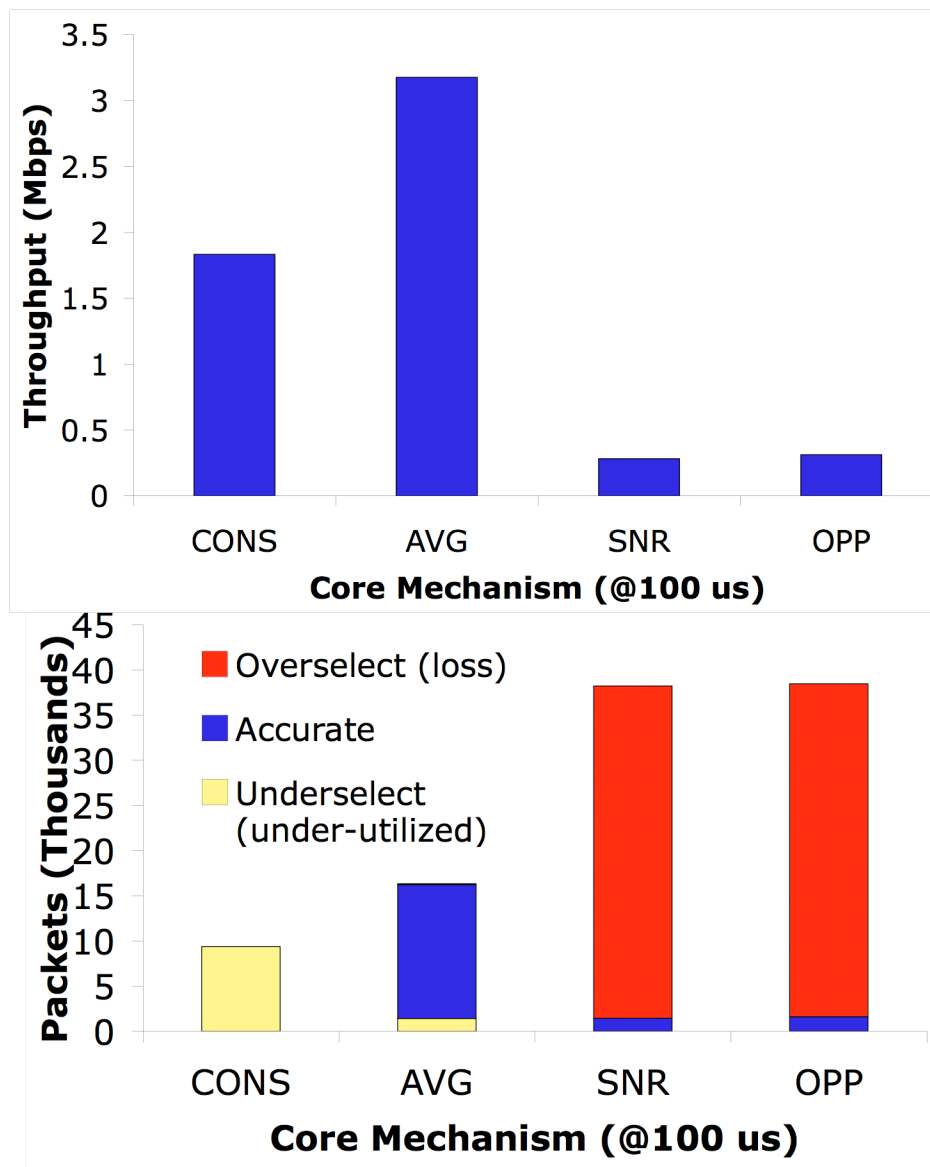

SNR-based Coherence Time Sensitivity



- Issue: SNR rate selection is per-packet (should track fading), why inaccurate?
- Fast to slow channel fading
 - Accurate at long coherence
 - Overselect at <1 ms
- Overselection caused by coherence time sensitivity of SNR-rate relationship

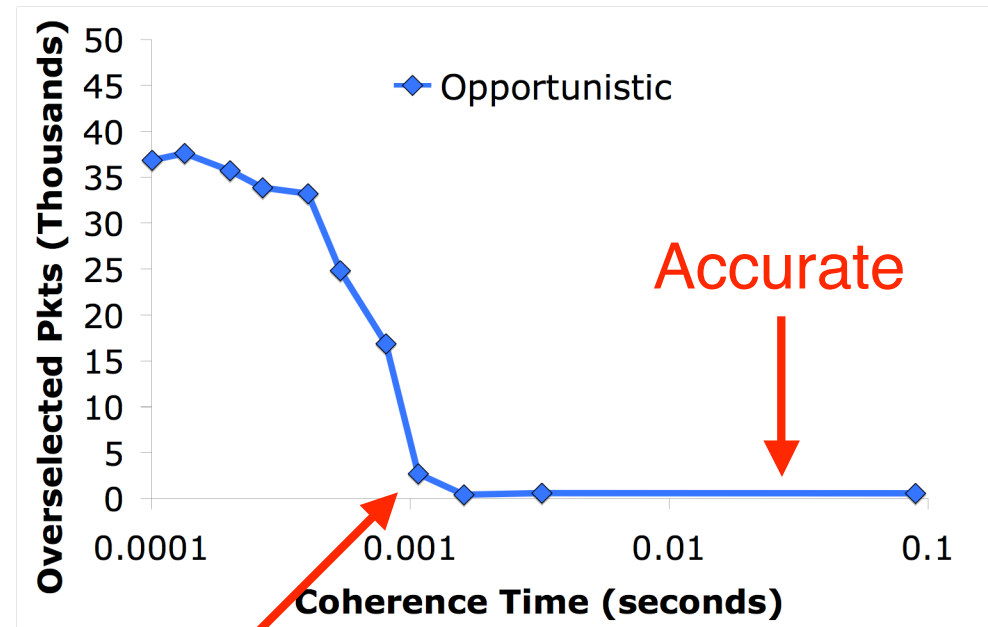

Begins to
Overselect

Joint Consideration of SNR and Coherence Time



- Consider different SNR thresholds according to coherence time
 - Ideal rate = $f(\text{SNR}, \text{CT})$

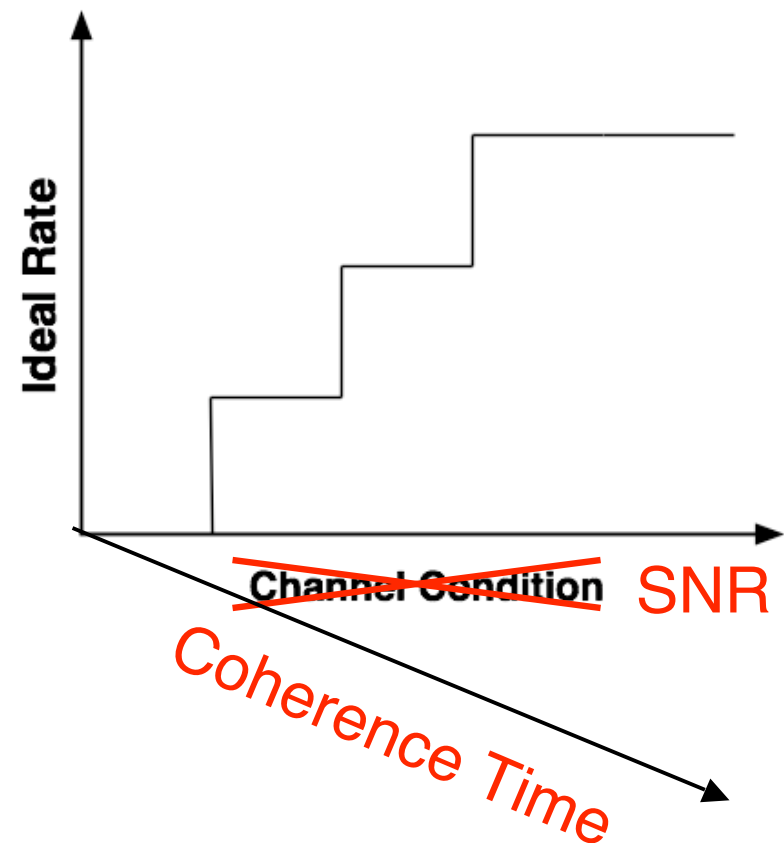

Joint Consideration of SNR and Coherence Time



- Consider different SNR thresholds according to coherence time
 - Ideal rate = $f(\text{SNR}, \text{CT})$
- Retrain SNR-based decision (for the same protocol)
- **Joint consideration of SNR and coherence time provides large gains**

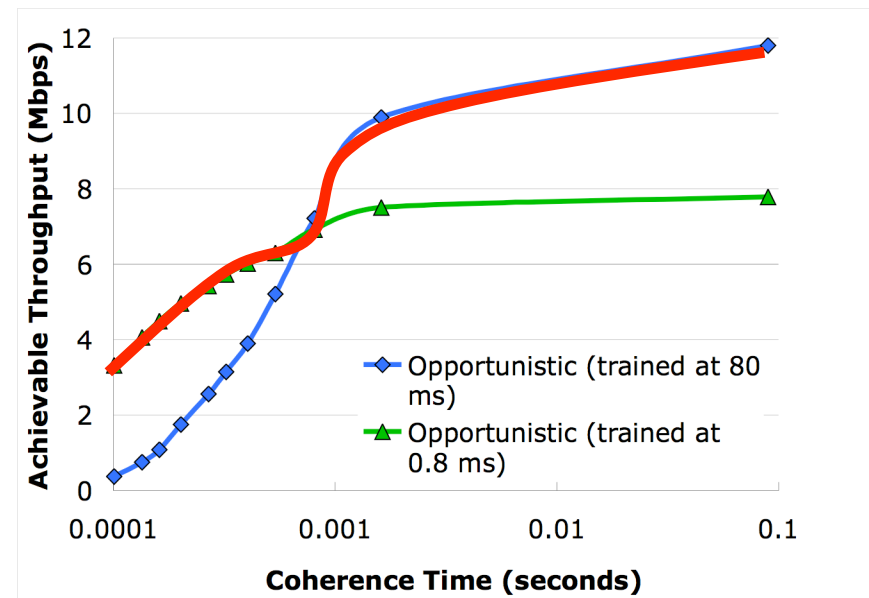

Scenarios and Channel Measurements



- Residential Urban (TFA)
 - Single-family residential, dense foliage
 - Coherence Time: 100 ms on average
 - Driven to 15 ms with mobility of scatterers (in static topology)

- Downtown Houston
 - Both sides of street lined with tall buildings (strong multipath)
 - Coherence Time: 80 ms on average
 - Driven to 300 usec with mobility of scatterers (in static topology)





Outdoor Static Topologies

- Issue: Evaluate rate adaptation accuracy in outdoor scenarios
- Consecutive and average: inaccurate in outdoor settings
- Downtown (strong multipath)
 - Force loss-based to underselect
 - SNR: over and underselect with low coherence time
- No long coherence times and equal performance as in lab

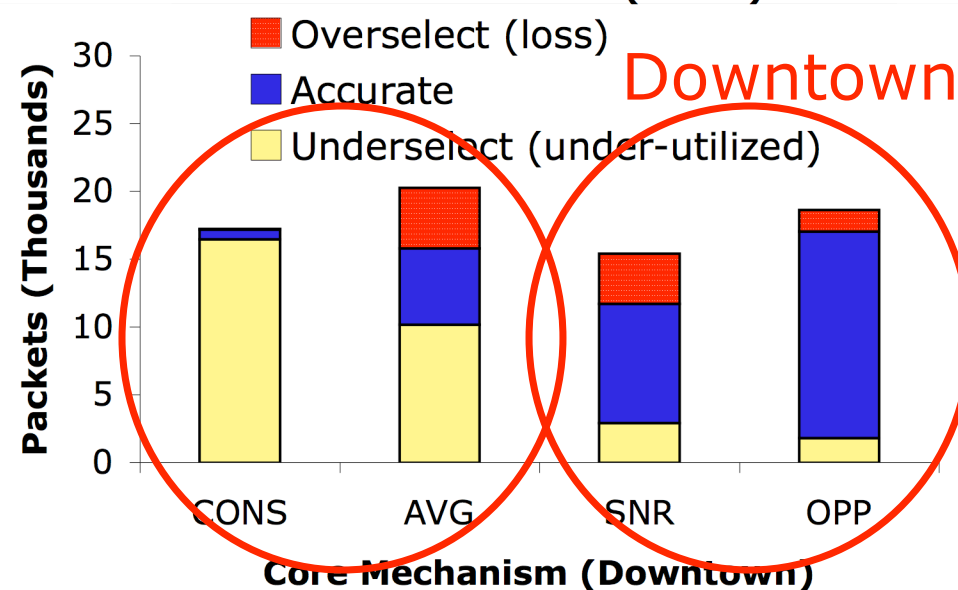
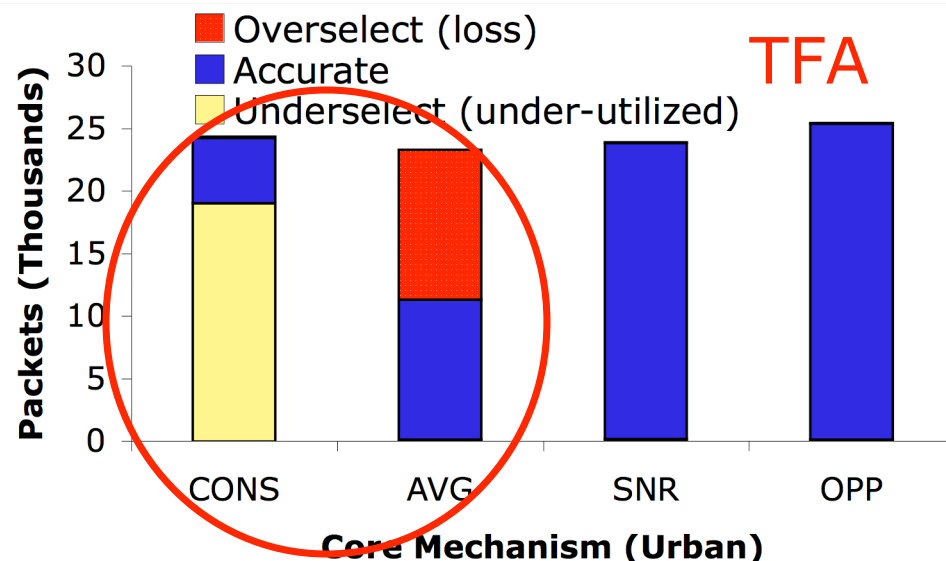



Static Sender to Mobile Receiver (Urban)

- Issue: Evaluate rate adaptation ability to track with mobility
- SNR protocols are able to plateau for >4 sec
 - Per-packet decision
- Loss-based protocols are only able to spike to suboptimal rate choices
 - Loss sensitivity prevents protocol from tracking
- **Loss-based protocols are unable to track with mobility**

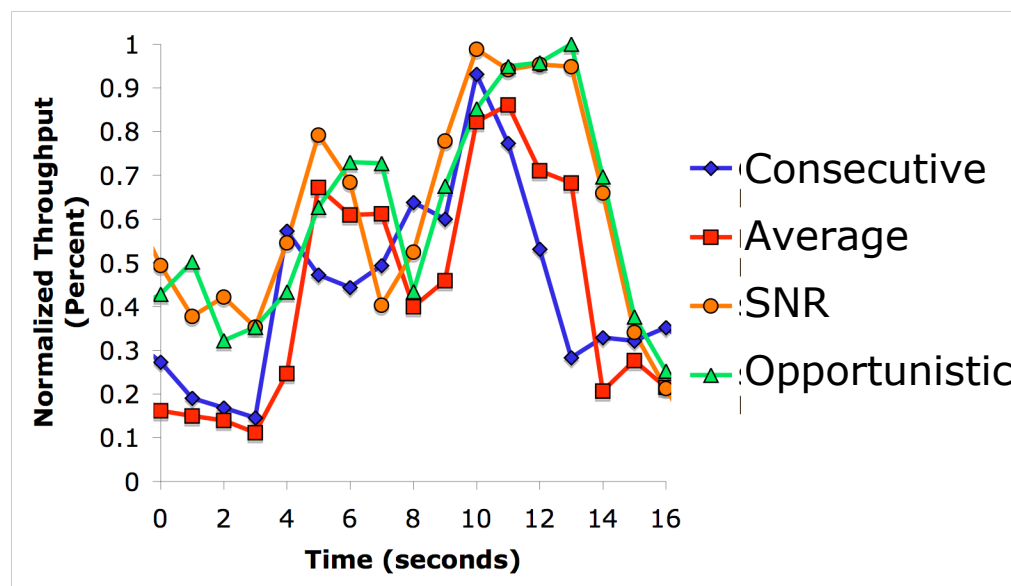
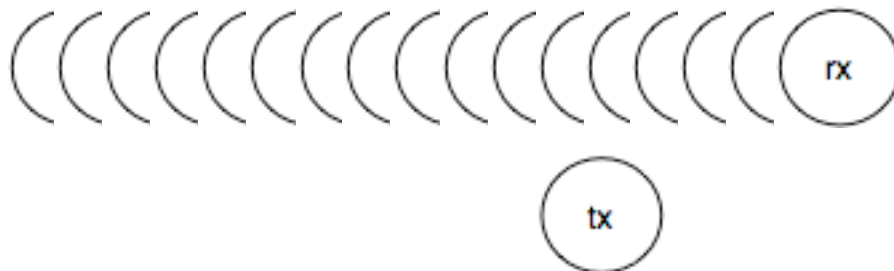



Heterogeneous Competing Links (in paper)

- Lack of loss distinction
 - Causes underselection
- Collision/Fading differentiation able to overcome with equal links
 - Large imbalances for **slight** differences in competing links
- Residential Urban Scenario
 - Competing links with vehicular mobility

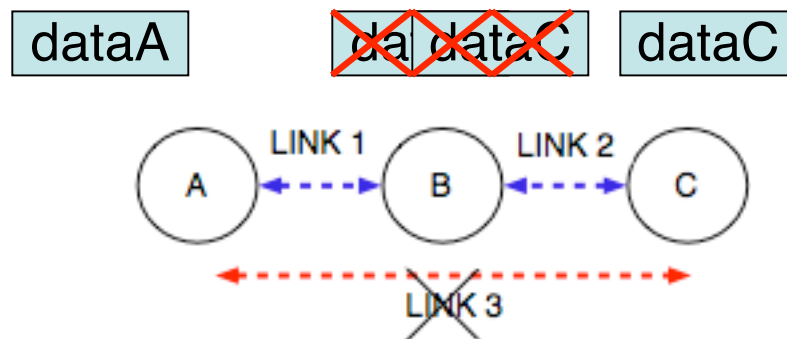



In Summary

- Implementation of multiple and previously unimplemented rate adaptation mechanisms and found via per-packet inspection:
- Loss-based core mechanisms **underselect** with
 - Fast-fading, interference, competing links (even with collision/fading differentiation), and mobile environments
- SNR-based mechanisms **overselect** with fast-fading but have
 - Large gains from considering SNR and coherence time jointly
 - **Robustness** to interference, competing links, and mobility
- Despite use of 4-way handshake, SNR-based protocols **outperform** loss-based protocols in practical environments

WARP: <http://warp.rice.edu>

TFA: <http://tfa.rice.edu>

RNG: <http://networks.rice.edu>